

GV-VD4702 4MP H.265 Super Low Lux WDR Pro IR Vandal Proof IP Dome



- 1/3" progressive scan super low lux CMOS
- Min. illumination at 0.02 lux
- Triple streams from H.265, H.264 and MJPEG
- Up to 20 fps at 2592 x 1520, 25 fps at 2560 x 1440, 30 fps at 2048 x 1520
- Vandal resistance (IK10)
- Ingress protection (IP67)
- Megapixel varifocal lens
- P-iris lens for auto iris control
- Intelligent IR
- IR distance up to 30 m (98.42 ft)
- Day and Night function (with removable IR-cut filter)
- 3-axis mechanism (pan / tilt / rotate)
- DC 12V / PoE (IEEE 802.3af)
- Two-way audio
- Wide Dynamic Range Pro (WDR Pro)
- 3D noise reduction
- Smart streaming
- Defog
- Motion detection
- Tampering alarm
- Text overlay
- Privacy mask
- IP address filtering
- Recording assigned by GV-Edge Recording Manager (Windows & Mac)
- Supports iPhone, iPad, Android & 3GPP
- 31 languages on Web interface
- ONVIF (Profile S) conformant

* Smart streaming requires either GV-DVR / NVR V8.7.0.0 or GV-VMS V16.10.3

Introduction

The Vandal Proof IP Dome is an outdoor camera designed with IK10 vandal resistance for metal casing and IP67 ingress protection. The camera can support H.265 video codec to achieve better compression ratio while maintaining high quality pictures at reduced network bandwidths. For night operations, the camera allows up to 30 m (98.4 ft) IR effective distance. GV-VD4702 is capable of providing a color live view in near darkness, and also under contrasting light intensities with its super low lux CMOS image sensor and WDR Pro.

Active Tampering Alarm

Tampered



Focus Change



Camera Shift

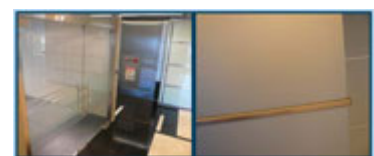

Dimensions

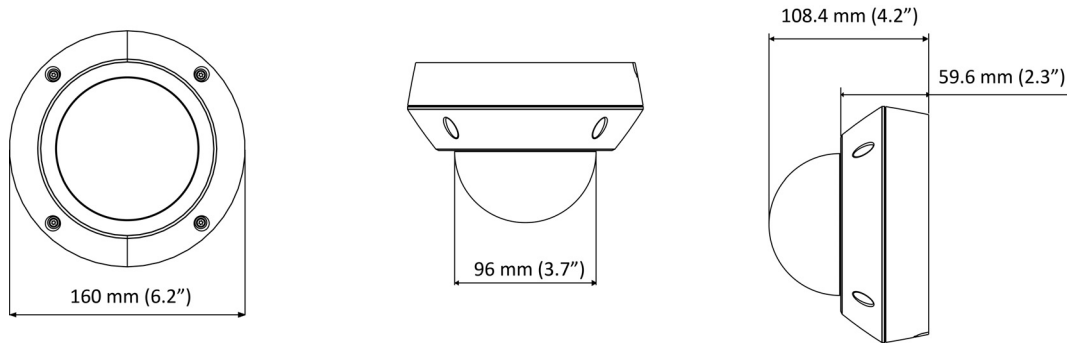

Specifications

Camera		
Image Sensor	1/3" progressive scan super low lux CMOS	
Picture Elements	2592 (H) x 1520 (V)	
Minimum Illumination	Color	0.03 Lux
	B/W	0.02 Lux
	IR ON	0 Lux
Shutter Speed	Automatic, Manual (1/5 ~ 1/16000 sec.)	
White Balance	Automatic, Manual (2800K ~ 8500K)	
Gain Control	Automatic	
S/N Ratio	50 dB	
WDR	WDR Pro	
Dynamic Range	Up to 120 dB	
Lens		
Megapixel	Yes	
Day/Night	Yes (with removable IR-cut filter)	
Focal Length	2.8 ~ 12 mm	
Lens Type	Varifocal	
Maximum Aperture	F/1.7	
Mount	Ø14 mm	
Horizontal FOV	102° ~ 36°	
Image Format	1/2.7"	
Operation	Focus	Manual (with lock)
	Zoom	Manual (with lock)
	Iris	P-iris
IR LED Quantity	4 IR LEDs	
Max. IR Distance	30 m (98.42 ft)	
Operation		
Video Compression	H.265, H.264, MJPEG	
Video Streaming	Stream 1 from H.265 or H.264	
	Stream 2 from H.265, H.264 or MJPEG	
	Stream 3 from H.265, H.264 or MJPEG	
Frame Rate	50 Hz: 20 fps at 2592 x 1520, 25 fps at 2560 x 1440, 25 fps at 2048 x 1520	
	60 Hz: 20 fps at 2592 x 1520, 24 fps at 2560 x 1440, 30 fps at 2048 x 1520 * The frame rate and the performance may vary depending on the number of connections and data bitrates (different scenes).	
Image Setting	Brightness, Contrast, Saturation, Sharpness, Gamma, White Balance, Flicker-less, Image Orientation, Shutter Speed, D/N Sensitivity, Backlight Compensation, WDR, Defog, Low Lux Enhancement, Denoise, Metering	
Audio Compression	G.711, AAC (Optional)	
Audio Support	Two-way Audio	
Sensor Input	1 input (dry contact)	
Alarm Output	1 digital output (200 mA 5V DC)	

Video Resolution		
Main Stream	4:3	2048 x 1520, 1600 x 1200, 1280 x 960, 640 x 480
	16:9	2592 x 1520, 2560 x 1440 (Default), 2304 x 1296, 1920 x 1080, 1280 x 720, 640 x 360
	5:4	1280 x 1024, 640 x 512
Sub Stream	4:3	1024 x 768, 640 x 480, 320 x 240
	16:9	1280 x 720, 640 x 360 (Default), 448 x 256
	5:4	1280 x 1024, 640 x 512, 320 x 256
Third Stream (Closed by Default)	4:3	640 x 480, 320 x 240
	16:9	640 x 360, 448 x 256
	5:4	640 x 512, 320 x 256
Network		
Interface	10/100 Ethernet	
Ethernet Protocol	DHCP, DNS, DynDNS, FTP, HTTP, HTTPS, ICMP, IPv4, IPv6, Multicast, NTP, ONVIF (Profile S), QoS (DSCP), RTP, RTCP, RTSP, SNMP, SMTP, SSL, TCP/IP, UDP, UPnP, 3GPP/ISMA	
Mechanical		
Temperature Detector	Yes	
Camera Angle Adjustment	Pan	0° ~ 350°
	Tilt	0° ~ 75°
	Rotate	0° ~ 340°
Connectors	Power	2-pin terminal block, PoE
	Ethernet	Ethernet (10/100 Base-T), RJ-45 cable
	Audio	1 In (microphone jack, 3.5 mm / 0.14") 1 Out (stereo phone jack, 3.5 mm / 0.14")
	Digital I/O	I/O wires
	Local Storage	Micro SD card slot (SD/SDHC/SDXC/UHS-I, Class 10) *UHS-II card type is not supported.
	TV-Out	BNC connector
LED Indicator	2 LEDs: Power, Status	
General		
Environment Temperature	Start-up	-20 °C ~ 50 °C (-4 °F ~ 122 °F)
	Operation	-30 °C ~ 50 °C (-22 °F ~ 122 °F)
Humidity	10% to 90% (no condensation)	
Power Source	12V DC / PoE (IEEE 802.3af)	
Max. Power Consumption	6.4 W	
Dimension	ø160 x 108.4 mm (6.2 x 4.27")	
Weight	1.15 kg (2.54 lb)	
Ingress Protection	IP67	
Vandal Resistance	IK10	
Regulatory	CE, FCC, RCM, LVD, RoHS compliant	
Power over Ethernet		
PoE Standard	PoE (IEEE 802.3af Power over Ethernet / PD)	
PoE Power Supply Type	End-Span and Mid-Span	
PoE Power Output	Per Port 48V DC, 350 mA. Max. 15.4 watts	
Web Interface		
Installation Management	Web-based configuration	
Maintenance	Firmware upgrade through Web Browser or Utility	
Access from Web Browser	Camera Live View, Video Recording, Change Video Quality, Bandwidth Control, Image Snapshot, Audio, Picture in Picture, Picture and Picture, Privacy Mask, Text Overlay, Digital PTZ	
Language	Arabic / Bulgarian / Czech / Danish / Dutch / English / Finnish / French / German / Greek / Hebrew / Hungarian / Indonesian / Italian / Japanese / Lithuanian / Norwegian / Persian / Polish / Portuguese / Romanian / Russian / Serbian / Simplified Chinese / Slovakian / Slovenian / Spanish / Swedish / Thai / Traditional Chinese / Turkish	

Applications

Software Supported	GV-DVR / NVR (V8.7.3.0), GV-VMS (V16.10.3.0), GV-Control Center (V3.4.0.0), GV-Edge Recording Manager (V1.2.0.0), GV-Center V2 (V16.10), GV-Recording Server / Video Gateway (V1.3.0.0), GV-Redundant / Failover Server (V1.1.0.0)
Smart Device Access	GV-Eye for iOS and Android
Remote Live Viewing	Browser (IE, Chrome, Firefox, Safari), Mobile app
CMS Server support	GV-Control Center, GV-Center V2, GV-Vital Sign Monitor

Note:

1. It is required to apply patch files to all the supported software mentioned above.
2. The signal range and data throughput may vary depending on the network conditions and environmental factors.
3. Specifications are subject to change without prior notice.









Packing List

- | | |
|--|----------------------------------|
| 1. H.265 Vandal Proof Dome | 13. Big Concave Hexagon Wrench |
| 2. Screw x 4 | 14. Small Concave Hexagon Wrench |
| 3. Screw Anchor x 4 | 15. Silica Gel Bag |
| 4. TV-Out Wire | 16. Sticker (for Silica Gel Bag) |
| 5. Audio Wire x 2 | 17. Ruler |
| 6. I/O Cable | 18. Download Guide |
| 7. Installation Sticker | 19. Warranty Card |
| 8. Conduit Converter | |
| 9. PG21 Conduit Connector | |
| 10. RJ-45 Connector | |
| 11. Waterproof Rubber Sets
(for RJ-45 Cat.5 and DC 12V / for RJ-45 Cat.6) | |
| 12. Torx Wrench | |

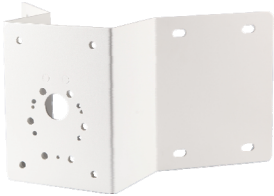
Note: Power adapters can be purchased upon request.

Accessories

Model No.	Name		Details
GV-Mount100	Straight Tube and Junction Box Kit		Dimensions: 200 x 170 x 257.5 mm (7.9 x 6.7 x 10.1") Weight: 3.17 kg (6.99 lb)
GV-Mount101	Straight Tube Kit		Dimensions: 219 x 125 x 332 mm (8.6 x 4.9 x 13.1") Weight: 1.8 kg (3.97 lb)
GV-Mount200	Wall Pendant Tube		Dimensions: 225 x 140 x 250 mm (8.9 x 5.5 x 9.8") Weight: 900 g (1.98 lb)

Model No.	Name		Details
GV-Mount203	Wall Pendant Tube and Junction Box Kit		Dimensions: 315 x 195.5 x 225 mm (12.4 x 7.7 x 8.9") Weight: 2.95 kg (6.5 lb)
GV-Mount206	Wall Mount Bracket Kit		Dimensions: 126.5 x 211.3 x 176.85 mm (5 x 8.3 x 6.96") Weight: 0.93 kg (2.06 lb)
GV-Mount300	Convex Corner Adapter Kit		Dimensions: 238.6 x 409.5 mm (9.4 x 16.1") Weight: 4.27 kg (9.41 lb)
GV-Mount310	Concave Corner Adapter Kit		Dimensions: 123.3 x 393.1 mm (4.9 x 15.5") Weight: 2.96 kg (6.53 lb)
GV-Mount400	Pole Mount Bracket Kit (Ø 4 ~ 6")		Bracket: 241 x 161 mm (9.5 x 6.3") Weight: 1.70 kg (3.75 lb) Steel Strap Diameter: Ø 4 ~ 6"
GV-Mount410	Pole Mount Bracket Kit (Ø 6 ~ 7.5")		Bracket: 241 x 161 mm (9.5 x 6.3") Weight: 1.70 kg (3.75 lb) Steel Strap Diameter: Ø 6 ~ 7.5"
GV-Mount702	Extension Tube		Four options are available. Dimensions: Ø 5.4 x 10 or 20 or 30 or 50 cm (Ø 2.1 x 3.9 or 7.9 or 11.8 or 19.7") Weight: 180 g or 390 g or 550 g or 800 g (0.4 lb or 0.86 lb or 1.21lb or 1.76 lb)
GV-Mount903	GV-VD Series Dome Housing		Dimensions: Ø 186 x 97.5 mm (Ø 7.3 x 3.8") Weight: 600 g (1.32 lb)

Model No.	Name		Details
GV-Mount916	In-Ceiling Mount		Dimensions: Ø 205 x 63.8 mm (Ø 8 x 2.5") Weight: 645 g
GV-PA191	PoE Adapter		Dimensions (H x W x D): 43 x 69 x 40 mm (1.69 x 2.72 x 1.57") Weight: 130 g (0.29 lb)
Metal PG21	Conduit Connector		The metal PG21 conduit connector allows you to run the wires through a 3/4" conduit pipe.
GV-Relay V2			The GV-Relay V2 is designed to expand the voltage load of GV IP devices. It provides 4 relay outputs, and each can be set as normally open (NO) or normally closed (NC) independently as per your requirement.
GV-POE Switch			The GV-POE Switch is designed to provide power along with network connection for IP devices. The GV-POE Switch is available in various models with different numbers and types of ports.
Power Adapter			Contact our sales representative for the countries and areas supported.