

GV-TVD8810 AI 8MP H.265 4.3x Zoom Super Low Lux WDR Pro IR Vandal Proof IP Dome



- AI Deep learning: AI Perimeter Protection & Classification (Human, Vehicle)
- 1/2.8" progressive scan low lux CMOS sensor
- Triple streams from H.265, H.264 or MJPEG
- Wide Dynamic Range Pro (WDR Pro)
- Min. illumination at 0.003 lux
- Up to 20 fps at 3840 x 2160
- Intelligent IR
- Day and night function (with removable IR-cut filter)
- Motorized varifocal lens for remote focus / zoom adjustment
- IR distance up to 40 m (130 ft)
- Vandal Resistance (IK10 for metal casing)
- Ingress protection (IP67)
- Built-in micro SD card slot (SD / SDHC / SDXC / UHS-I, Class 10) for local storage
- Two-way audio
- DC 12V / PoE (IEEE 802.3af)
- ONVIF (Profile G, S, T) conformant



Introduction

The Dome IP Camera is an outdoor, network camera equipped with an automatic IR-cut filter and IR LEDs for day and night surveillance. The camera supports H.265 video codec to achieve better compression ratio while maintaining high quality pictures at reduced network bandwidths. GV-TVD8810 adheres to IK10 and IP67 standards, and can be powered through PoE.

Empowered by deep learning algorithms, AI technology distinguishes human and vehicles from other moving objects. Integrated with GeoVision Video Management Software (VMS), it supports AI perimeter protection, real time alert, events playback and more.

Deep Learning Function

AI Perimeter Protection
(Intrusion, Crossing Line
Entering Area, Leaving Area)

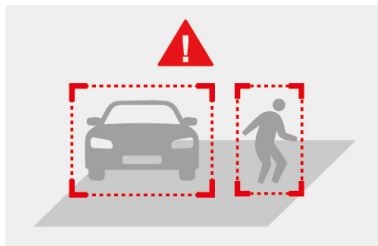

AI Event Search
(VMS V18.3 or later)



Note: The integration of AI events of the camera to GV-VMS is coming soon.

Dimensions

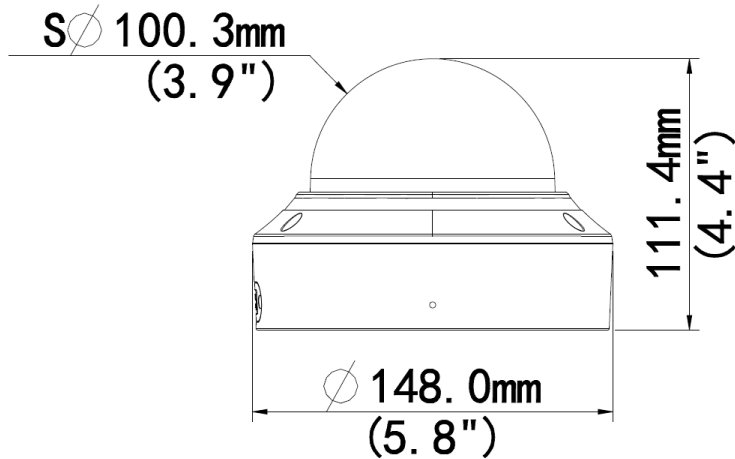

Specifications

| Camera | | |
|----------------------|---|---|
| Image Sensor | 1/2.8" progressive scan low lux CMOS | |
| Picture Elements | 3840 (H) x 2160 (V) | |
| Minimum Illumination | Color | 0.003 Lux (F1.6, AGC ON) |
| | IR On | 0 Lux |
| Shutter Speed | Auto / Manual (1 ~ 1/100000 sec) | |
| White Balance | Auto / Manual | |
| Gain Control | Auto / Manual | |
| S/N Ratio | 56 dB | |
| WDR Pro | Yes | |
| Dynamic Range | Up to 120 dB | |
| Lens | | |
| Megapixel | 8 MP | |
| Day / Night | Yes (with removable IR-cut filter) | |
| Lens Type | Motorized varifocal lens | |
| Focal Length | 2.8 ~ 12 mm | |
| Maximum Aperture | F/1.6 | |
| Mount | $\varnothing 14$ mm | |
| Horizontal FOV | 34 ~ 106° | |
| Operation | Focus | Auto / Manual |
| | Zoom | 4.3x Optical Zoom |
| | Iris | Fixed |
| IR LED Quantity | 2 IR LEDs | |
| Max. IR Distance | 40 m (130 ft) | |
| Operation | | |
| Video Compression | H.265, H.264, MJPEG | |
| Video Streaming | Triple streams | |
| Video Resolution | Main Stream | 3840 x 2160 (Default), 3072 x 1728, 2560 x 1440, 1920 x 1080 |
| | Sub Stream | 1920 x 1080, 1280 x 720, 720 x 576, 704 x 288, 640 x 360 (Default), 352 x 288 |
| | Third Stream (Closed by Default) | 720 x 576, 704 x 288, 640 x 360, 352 x 288 |
| Frame Rate | 20 fps at 3840 x 2160, 25 fps at 3072 x 1728 / 2560 x 1440, 30 fps at 1920 x 1080 (60 / 50 Hz) *The frame rate and performance may vary depending on the number of connections and data bitrates (different scenes). | |
| Video Analytics | Motion Detection, Tampering Alarm, Audio Detection *Tampering alarm and Audio detection are only accessible through the camera's Web interface, which can be used to trigger alerts such as e-mail and FTP | |
| Image Setting | Brightness, Contrast, Saturation, Sharpness, Flicker-less, Image Orientation (Flip, Mirror, 0°, 90°, 180°, 270°-including Corridor format) | |

| | | |
|-------------------------------|--|---|
| Audio Compression | G.711 | |
| Audio Support | Two-way Audio (external speaker required) | |
| Digital I/O | Input | 1 Input, dry contact, NO / NC |
| | Output | 1 Relay Output (1A 30V DC / 0.3A 125V AC) |
| Deep Learning Function | | |
| AI Perimeter Protection | Intrusion, Crossing Line, Entering Area, Leaving Area (Human & Vehicle classification) | |
| Network | | |
| Interface | 10/100 Ethernet | |
| Protocol | ARP, DHCP, DDNS, DNS, DynDNS, FTP, HTTP, HTTPS, ICMP, IGMP, IPv4, NTP, PPPoE, RTCP, RTP, RTSP, SMTP, TCP, UDP, UPnP, ONVIF (Profile G, S, T) | |
| Mechanical | | |
| Camera Angle Adjustment | Pan | 0 ~ 360° |
| | Tilt | 0 ~ 68° |
| | Rotate | 0 ~ 360° |
| Connectors | Power | DC Jack, PoE |
| | Ethernet | RJ-45 |
| | Audio | 1 In (built-in or external microphone with power supply) 1 Out (Audio Out Wire) |
| | Digital I/O | 4-pin terminal block pitch 3.5 mm (0.14") |
| | Local Storage | Micro SD card slot (SD / SDHC / SDXC / UHS-I, Class 10) * UHS-II card type is not supported. |
| General | | |
| Operating Temperature | -30 ~ 60°C (-22 ~ 140°F) | |
| Humidity | 0 ~ 95% (no condensation) | |
| Power Source | 12 V DC / PoE (IEEE802.3af) | |
| Max. Power Consumption | 5.5 W | |
| Dimensions | Ø148 x 111 mm (Ø5.8 x 4.4") | |
| Weight | 0.45 kg (0.99 lb) | |
| Ingress Protection | IP67 | |
| Vandal Resistance | IK10 for metal casing | |
| Regulatory | FCC, CE, RoHS compliant | |
| Web Interface | | |
| Installation Management | Web-based configuration | |
| Maintenance | Firmware upgrade through Web Browser or GV-IP Device Utility | |
| Access from Web Browser | Live View, Video Recording, Change Video Quality, Bandwidth Control, Image Snapshot, Text Overlay, Image Masking | |
| Language | Czech, English, French, German, Hungarian, Italian, Japanese, Polish, Portuguese, Russian, Spanish, Traditional Chinese | |
| Software Application | | |
| Software Supported | GV-VMS (V17.4.1 / V18.2.1), GV-DVR / NVR (V8.9.1), GV-Control Center (V3.8.0), GV-Recording Server / Video Gateway (V2.0.0), GV-Edge Recording Manager Win version (V2.0.0), GV-Redundant / Failover Server (V1.2.0) | |
| Smart Device Access | GV-Eye for iOS and Android | |
| Live Viewing | Browser (IE, Edge, Chrome), Mobile App | |









Note:

1. It is required to apply patch files to all or some of the supported software.
2. Do not use clothes or any ordinary material to clean the camera cover since they may result in scratches.
3. Specifications are subject to change without notice.

Packing List

- | | |
|------------------------------------|-------------------|
| 1. GV-TVD8810 IR Vandal Proof Dome | 5. Torx Wrench |
| 2. Waterproof Rubber Set | 6. Download Guide |
| 3. Screw Kit | 7. Warranty Card |
| 4. Drill Template Paster | |

Accessories

| Model No. | Name | | Details |
|---|--|--|--|
| GV-Mount107 (must be used with GV-Mount212-2) | Pendant Bracket |  | Dimensions: \varnothing 120 x 334 mm (\varnothing 4.72" x 13.15") Weight: 0.74 kg (1.63 lb) |
| GV-Mount211-2 | Wall Mount and Junction Box |  | Dimensions: \varnothing 253 x 125 x 125 mm (\varnothing 10 x 4.9 x 4.9") Weight: 0.92 kg (2.02 lb) |
| GV-Mount212-2 | Wall Box Mount |  | Dimensions: \varnothing 145 x 40 mm (\varnothing 5.7 x 1.6") Weight: 0.24 kg (0.5lb) |
| GV-Mount300-2 | Convex Corner Mount |  | Dimensions: 137 x 233 x 160 mm (5.4" x 9.17" x 6.3") Weight: 1.65 kg (3.64 lb) |
| GV-Mount310-2 | Concave Corner Mount |  | Dimensions: 111.2 x 369.9 x 210 mm (2.6" x 11.4" x 6.6") Weight: 1.65 kg (3.64 lb) |
| GV-Mount420 (must be used with GV-Mount211-2) | Pole Mount Bracket |  | Dimensions: \varnothing 20 x 120 x 53.4 mm (\varnothing 4.7 x 4.7 x 2.1") Steel Strap Diameter: \varnothing 67 ~ 127 mm (\varnothing 2.6" ~ 5") Weight: 0.45 kg (0.99 lb) |
| GV-Mount606 | In-Ceiling Mount |  | Dimensions: \varnothing 235 x 63 mm (\varnothing 9.3" x 2.5") In-ceiling hole: \varnothing 195 mm (\varnothing 7.67") Weight: 0.49 kg (1.1 lb) |
| GV-Mount704 (must be used with GV-Mount107) | Extension Tube |  | Dimensions: \varnothing 3.5 x 10 or 20 or 30 or 50 cm (\varnothing 1.38 x 3.9 or 7.9 or 11.8 or 19.7") Weight: 225g or 360g or 500g or 780g (0.5 lb or 0.79 lb or 1.1 lb or 1.72 lb) |
| GV-PA191 | Power over Ethernet (PoE) Adapter |  | GV-PA191 is a Power over Ethernet (PoE) adapter designed to provide power to the IP device through a single Ethernet cable. |
| GV-POE Switch | GV-POE Switch is designed to provide power along with network connection for IP devices. The GV-POE Switch is available in various models with different numbers and types of ports. | | |
| Power Adapter | Contact our sales representatives for the countries and areas supported. | | |