

GV-SD4834-IR AI 4MP 33x Zoom H.265 Super Low Lux WDR Pro Outdoor IR IP

Speed Dome



- AI deep learning: AI Perimeter Protection & Classification (Human, Vehicle)
- 1/2.8" progressive scan CMOS sensor
- Min. illumination at 0.003 lux
- Triple streams from H.265, H.264 or MJPEG
- Up to 30 fps at 2688 x 1520
- Motorized varifocal lens for remote focus / zoom adjustments
- 33x optical zoom and unlimited digital zoom
- Intelligent IR
- IR distance up to 150 m (500 ft)
- Day and night function (with removable IR-cut filter)
- Two sensor inputs and one alarm output
- Wide Dynamic Range Pro (WDR Pro)
- Ingress protection (IP66)
- Vandal resistance (IK10 for metal casing)
- Wide temperature tolerance (-40°C ~ 65°C / -40°F ~ 149°F)
- Support for TV-out
- Two-way audio
- Built-in micro SD card slot (SD / SDHC / SDXC / UHS-I, Class 10) for local storage
- DC 24V / AC 24V / PoE+ (IEEE 802.3at)
- Pan 360° endlessly
- Tilt from -15° to 90°
- Pan and tilt speed of up to 300°/sec and 240°/sec, respectively
- PTZ movement (Preset, Auto Pan and Patrol)
- PTZ patrol by schedule
- AI analytics (Cross Line, Intrusion, Auto Tracking, Enter Area, Leave Area, Face Detection, People Flow Counting, Crowd Density Monitoring)
- Auto focus
- 3D noise reduction
- Motion detection
- Privacy mask
- ONVIF (Profile G, S, T) conformant

Introduction

GV-SD4834-IR is an outdoor network PTZ camera that offers 33x optical zoom and unlimited digital zoom, capable of showing smooth live view with great details. This camera can simultaneously deliver three video streams in resolutions up to 2688 x 1520 at 30 fps. In low-light environments, night vision is enhanced with its high-power LEDs, which allow up to 150 m (500 ft) effective IR distance. The camera can process scenes with contrasting intensity of lights and produce clear image using the built-in WDR Pro. The camera supports H.265 video codec to achieve better compression ratio while maintaining high quality pictures at reduced network bandwidths. It also adheres to IP66 and IK10 standards.

Empowered by deep learning algorithms, AI technology distinguishes human and vehicles from other moving objects. GV-SD4834-IR supports AI perimeter protection, people flow counting, auto tracking, motion detection, audio detection and more.

Deep Learning Function

Face Detection



AI Perimeter Protection

(Intrusion, Crossing Line
Entering Area, Leaving Area)

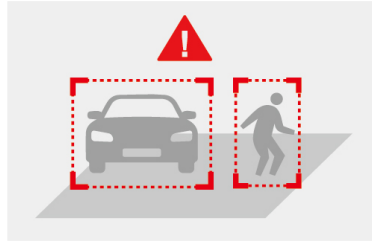

People Counting

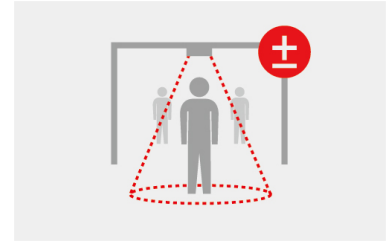

Note: The integration of AI events of the camera to GV-VMS is coming soon.

Dimensions

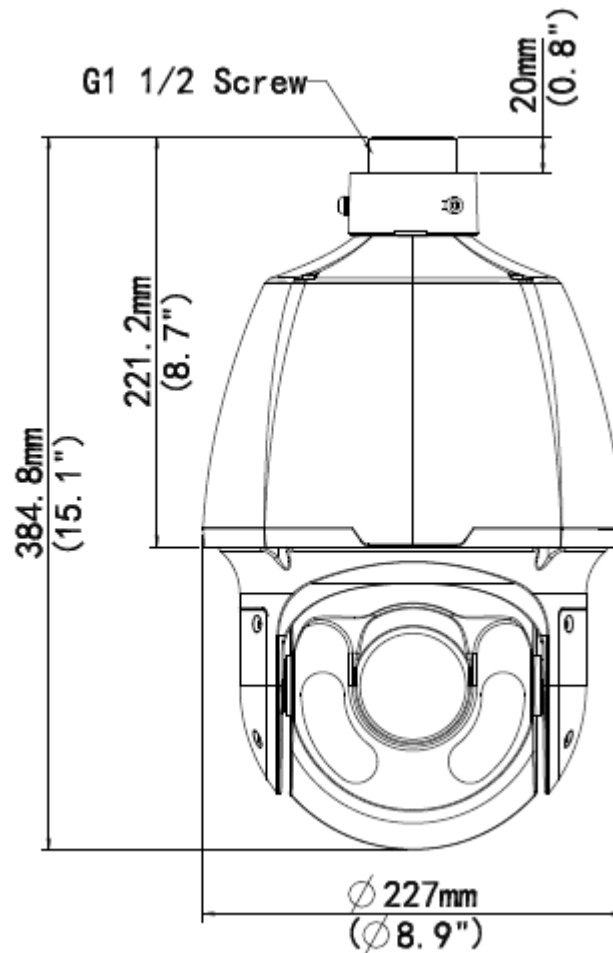

Specifications

Camera		
Image Sensor		1/2.8" progressive scan CMOS
Optical Zoom		33x
Minimum Illumination	Color	0.003 Lux (F1.5, AGC ON)
	IR ON	0 Lux
Electronic Shutter		Auto / Manual (1 ~ 1/100000 sec)
White Balance		Auto / Manual
Iris control		Auto / Manual

AGC control	Auto / Manual	
S/N Ratio	56 dB	
WDR	WDR Pro	
Dynamic Range	Up to 120 dB	
Optical Lens		
Megapixel	4 MP	
Day / Night	Yes (with removable IR-cut filter)	
Focal Length	4.5 ~ 148.5 mm	
Lens Type	Motorized varifocal lens	
Maximum Aperture	F1.5	
Horizontal FOV	53.0° ~ 2.3°	
Operation	Focus	Auto / Manual
	Zoom	33x
	Iris	Auto / Manual
IR LED Quantity	6 IR LEDs	
Max. IR Distance	150 m (500 ft)	
Video		
Video Compression	H.265, H.264, MJPEG	
Video Streaming	Triple streams from H.265, H.264 or MJPEG	
Video Resolution	Main Stream	2688 x 1520 (Default), 2560 x 1440, 1920 x 1080, 1280 x 720, 720 x 576, 640 x 360.
	Sub Stream	1920 x 1080, 1280 x 720, 720 x 576, 640 x 480, 640 x 360 (Default)
	Third Stream (Closed by Default)	720 x 576, 704 x 288, 640 x 360, 352 x 288
Frame Rate	30 fps at 2688 x 1520, 30 fps at 2560 x 1440, 30 fps at 1920 x 1080 (60 / 50 Hz) * The frame rate and performance may vary depending on the number of connections and data bitrates (different scenes).	
Video Analytics	Motion Detection, Tampering Alarm, Audio Detection *Tampering alarm and audio detection are only accessible through the camera's Web interface, which can be used to trigger alerts such as e-mail and FTP	
Image Setting	Brightness, Contrast, Saturation, Sharpness, Flicker-less, Image Orientation (Flip, Mirror, 0°, 90°, 180°, 270°-including Corridor format)	
Audio		
Audio Compression	G.711	
Audio Support	Two-way Audio (external microphone and speaker required)	
Deep Learning Function		
AI Analytics	Cross Line, Intrusion, Auto Tracking, Enter Area, Leave Area, Face Detection, People Flow Counting, Crowd Density Monitoring	
Network		
Interface	10/100 Ethernet	
Protocol	802.1x, ARP, DHCP, DDNS, DNS, DynDNS, FTP, HTTP, HTTPS, ICMP, IGMP, IPv4, NTP, PPPoE, QoS, RTCP, RTP, RTSP, SMTP, SNMP, TCP, UDP, UPnP, ONVIF (Profile G, S, T)	
Mechanical		
Connectors	Power	3-pin terminal block (DC 24V, 2.5A / AC 24V, 2.2A), PoE+ (IEEE 802.3at)
	Ethernet	10/100 Base-TX, RJ-45 connector
	Audio	1 in (Audio In Wire); 1 out (Audio Out Wire) *The Audio In port only supports microphones with power supply.
	Local Storage	Micro SD card slot (SD / SDHC / SDXC / UHS-I, Class 10) * UHS-II card types are not supported.
	TV-Out	BNC connector: NTSC (720 x 576 at 30 fps), PAL (720 x 576 at 25 fps)
	Digital I/O	I/O wires
	RS-485	RS-485 wires
Operation		
Pan Travel	360° endless	
Tilt Travel	-15° ~ 90°	
Manual Speed	Pan	0.1° ~ 200°/s
	Tilt	0.1° ~ 200°/s
Preset Speed	Pan	300°/s
	Tilt	240°/s

Presets	Max. Number	255
	Accuracy	0.1°
Patrol	Max. Number	16
	Max. Actions Allowed	32
OSD		8
Privacy Mask		24
Proportional Pan & Tilt		Auto (Pan and tilt speed proportional to zoom ratio)
Automatic Function		Preset, Patrol (Including Auto Pan)
Mechanical Flip		Yes
Digital Slow Shutter		On / Off
Motion Detection		On / Off
Wide Dynamic Range		On / Off
Day/Night: Mechanical IR Cut Filter		On / Off
Image Rotation		Normal, Flip Vertical, Flip Horizontal, 180°, 90° Clockwise, 90° Anti-clockwise
3D Noise Reduction		0 ~ 255
Alarm	Digital I/O	2 Inputs, dry contact, NO / NC
		1 Relay Output (AC 125V 0.5A / DC 30V 1A)
	Reaction	Alarm Output, PTZ to Preset, Trigger Storage
General		
Operating Temperature		-40°C ~ 65°C (-40°F ~ 149°F)
Humidity		20% ~ 90% (non-condensing)
Dimensions		Ø227 x 384.8 mm (Ø8.9" x 15.1")
Weight		5.28 kg (11.64 lb)
Power Source		AC 24V, DC 24V, PoE+ (IEEE 802.3at)
Power Consumption		25W
Ingress Protection		IP66
Vandal Resistance		IK10 for metal casing
Regulatory		CE, FCC, RoHS compliant
Web Interface		
Installation Management		Web-based configuration
Maintenance		Firmware upgrade through Web Browser or Utility
Access from Web Browser		Live View, Video Recording, Change Video Quality, Bandwidth Control, Image Snapshot, Text Overlay, Image Masking
Language		Czech, English, French, German, Hungarian, Italian, Japanese, Polish, Portuguese, Russian, Spanish, Traditional Chinese
Software Applications		
Software Supported		GV-DVR / NVR (V8.9.1), GV-VMS (V17.4.3 / V18.2.1), GV-Control Center (V3.8.0 / V4.0.1), GV-Edge Recording Manager Windows Version (V2.0.0), GV-Recording Server / Video Gateway (V2.0.0), GV-Redundant / Failover Server (V1.2.0), GV-Mobile Server (V1.5.1), GV-AI Guard (V1.0.0)
Smart Device Access		GV-Eye for iOS and Android
Live Viewing		Bowser (IE, Edge, Chrome, Firefox, Safari), Mobile App







Note:



- It is required to apply patch files to the supported software.
- Do not use clothes or any ordinary material to clean the camera cover since they may result in scratches.
- Mind the following when using an inserted memory card for recording:
 - Recorded data on the memory card can be damaged or lost if the data are accessed while the camera is under physical shock, power interruption, memory card detachment or when the memory card reaches the end of its lifespan. No guarantee is provided for such causes.
 - The stored data can be lost if the memory card is not accessed for a long period of time. Back up your data periodically if you seldom access the memory card.
 - Memory cards are expendable and their durability varies according to the conditions of the installed site and how they are used. Back up your data regularly and replace the memory card annually.
 - To avoid power outage, it is highly recommended to apply a battery backup (UPS).
 - For better performance, it is highly recommended that you use a micro SD card of SDHC/SDXC, Class 10.
 - Replace the memory card when its read/write speed is lower than 6 MB/s or when the memory card is frequently undetected by the camera.
- Specifications are subject to change without notice.

Packing List

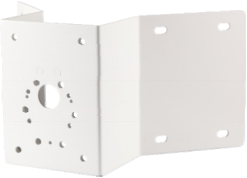
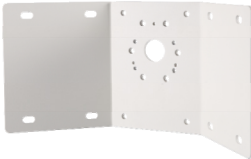
1. GV-SD4834-IR Speed Dome
2. M4 Hex Key
3. Waterproof Rubber Set
4. Waterproof Guidelines
5. Download Guide

Accessories

Model No.	Name		Details
GV-Mount104	Straight Tube Kit		Dimensions: 219 x 125 x 332 mm (8.6" x 4.9" x 13.1") Weight: 1.8 kg (3.97 lb)
GV-Mount105	Straight Tube and Junction Box Kit		Dimensions: 256 x 256 x 297 mm (10.1" x 10.1" x 11.7") Weight: 6.2 kg (13.67 lb)
GV-Mount208-3	Swan Neck Mount		Dimensions: 1043 x 519 x 256 mm (41.06" x 20.43" x 10.08") Weight: 10.6 kg (23.37 lb)
GV-Mount210	Wall Pendant Mount		Dimensions: 200 x 140 x 249 mm (7.9" x 5.5" x 9.80") Weight: 1.1 kg (2.43 lb)
GV-Mount300-1	Convex Corner Adapter Kit		Dimensions: 238.6 x 395.2 x 210 mm (9.4" x 15.5" x 8.2") Weight: 4.27 kg (9.41 lb)
GV-Mount310-1	Concave Corner Adapter Kit		Dimensions: 111.2 x 369.9 x 210 mm (4.37" x 14.5" x 8.2") Weight: 2.96 kg (6.53 lb)
GV-Mount400-1	Pole Mount Bracket Kit (Ø 4" ~ 6")		Bracket: 68.4 x 240 x 163 mm (2.69" x 9.44" x 6.41") Weight: 1.70 kg (3.75 lb) Steel Strap Diameter: Ø 4" ~ 6"

GV-Mount410-1	Pole Mount Bracket Kit (Ø 6" ~ 7.5")		Bracket: 68.4 x 240 x 163 mm (2.69" x 9.44" x 6.41") Weight: 1.70 kg (3.75 lb) Steel Strap Diameter: Ø 6" ~ 7.5"
GV-Mount501	Convex Corner Box Mount		Dimensions: 136 x 256 x 256 mm (5.4" x 10.1" x 10.1") Weight: 4.8 kg (10.6 lb)
GV-Mount702	Extension Tube		Four options are available. Dimensions: Ø 5.4" x 10" or 20 or 30 or 50 cm (Ø 2.1" x 3.9" or 7.9" or 11.8" or 19.7") Weight: 180 g or 390 g or 550 g or 800 g (0.4 lb or 0.86 lb or 1.21 lb or 1.76 lb)
GV-POE Switch	GV-POE Switch is designed to provide power along with network connection for IP devices. The GV-POE Switch is available in various models with different numbers and types of ports.		
Power Adapter	Contact our sales representatives for the countries and areas supported.		